

**TECHNOLOGY**

**PLANNING AND  
DESIGN**

**COLLABORATION  
THAT INNOVATES**

**Laboratory  
of the Half  
Century**

**ENERGY/  
SUSTAINABILITY**

**SYNERGY**

**FUNDING AND  
PARTNERSHIPS**



**Lawrence Berkeley National Laboratory** Chu Hall Berkeley, CA

# LAB2050 | Table of Contents

04	Overview
06	Linkages
08	Technology
10	Collaboration that Innovates
12	Synergy
14	Funding and Partnerships
16	Energy and Sustainability
18	Planning and Design
20	Key Takeaways
22	Acknowledgments



Ed Burton, RIBA  
Science & Technology Practice Director  
213.228.6923 | ed.burton@smithgroupjjr.com

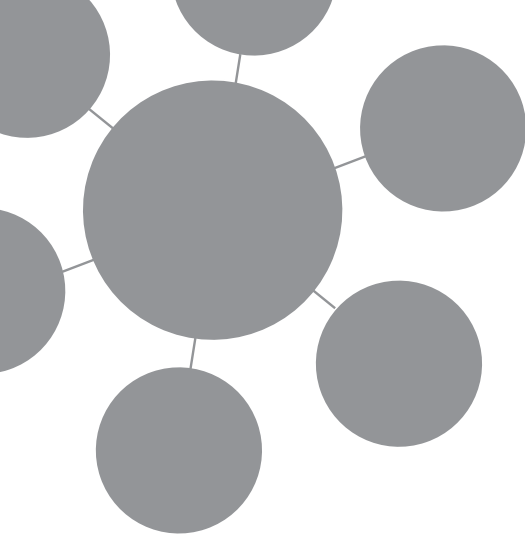

# LAB2050 | Overview

The Laboratory of the Half Century (AKA Lab2050) is an inspirational initiative SmithGroupJJR embarked on to dig deep into the scientific trends, new technologies and economics that will shape the design concepts of research laboratory environments in the next decades.

In 2001, the firm's Science & Technology practice took on a similar initiative—Lab2020. At that time, we conducted a national inquiry with leading academic research institutions to better understand requirements for future research spaces. Science was rapidly expanding into new frontiers, the practice revisited that concept in 2007. Again, it reached out to institutional clients to understand the trends and ideas that influenced laboratory design in the next decades. Fittingly, that was coined Lab2030.

Now, we believe that the research landscape is continuing its rapid pace of change and evolution. Funding is tighter than ever, collaborations are crucial to secure tight money or find non-federal dollars, technology continues to advance at an escalating pace and interdisciplinary interactions are the norm in almost every industry. These factors are having a powerful impact on the future of science and research, including the environments in which it takes place. SmithGroupJJR wants to be at the forefront of that change with transformative programming, planning and design solutions.

To dig deep into these challenges, LAB2050 is divided into six sub-categories focused on common themes often discussed in today's research environment. Those are:

- Technology
- Collaboration that Innovates
- Synergy
- Funding and Partnerships
- Energy and Sustainability
- Planning and Design

Each theme was led by knowledge experts within the Science & Technology practice and included a group of emerging leaders within the firm to expand their professional development and knowledge of the market. The groups consulted with an assigned member of our esteemed Advisory Board, which is a group of leaders from scientific and research facilities across the country that SmithGroupJJR has met with regularly since 2011 to continually learn and share ideas with. The advisors discussed concepts and perspectives with their respective team throughout the initiative and peer-reviewed the concluding research.

Teams were tasked with understanding how the six themes will evolve from their current state to the future. A hypothesis was created for each, giving teams a solid place to start their research. The following pages review the hypotheses, research and the impact on future science and laboratory design and planning.

LAB2050 commenced in early-2015 and is informally concluding with this chapter-based white paper. We intend for this to be an ongoing project that is updated when scientific practices and trends shift. Feedback and critiques on our findings and conclusions are appreciated and welcomed—the dialogue remains open in an effort to advance research facility design and practices.



**LABS 2020, 2030 and 2050** Evolution

<b>SPACE</b>	Open Labs Prevalent	Open Labs / High Visibility	Open Labs / Computational
<b>PROCESS</b>	Increased Automation	Clinical Dry Research	Robotic Science Partners
<b>TECHNOLOGY</b>	Increased Computerization	Bioinformatics / Cloud	Big Data Driven
	More Intense Equipment (SEM)	Imaging Cores (NMR, TEM)	Biomarkers / Biobots
	Mirco, Mobile, Computational	Molecular Modeling / Proteomics	Precision Medicine / Genomics
<b>LABS</b>	Flexible Wet to Dry	Mobile, Flexible, Data	Less Bench, More Touch Down
<b>COLLABORATION</b>	Collaboration Areas	Interactive Commons	Integrated Collaboration Zones
	Interactive Cross Disciplinary	Interdisciplinary / Virtual	Partnerships v. Solo
<b>SYNERGIES</b>	Intellectual v. Process	Science with Engineering	Science / Business / Marketing
<b>SUSTAINABILITY</b>	Sustainable Buildings	Net-Zero / Net-Positive	Low-Entropy Campus
<b>SYSTEMS</b>	Zone Sensored HVAC Systems	Real-time Monitoring Systems	Intelligent Building Systems

**LAB2020**  
(held in 2001)

**LAB2030**  
(held in 2007)

**LAB2050**  
(held in 2015)

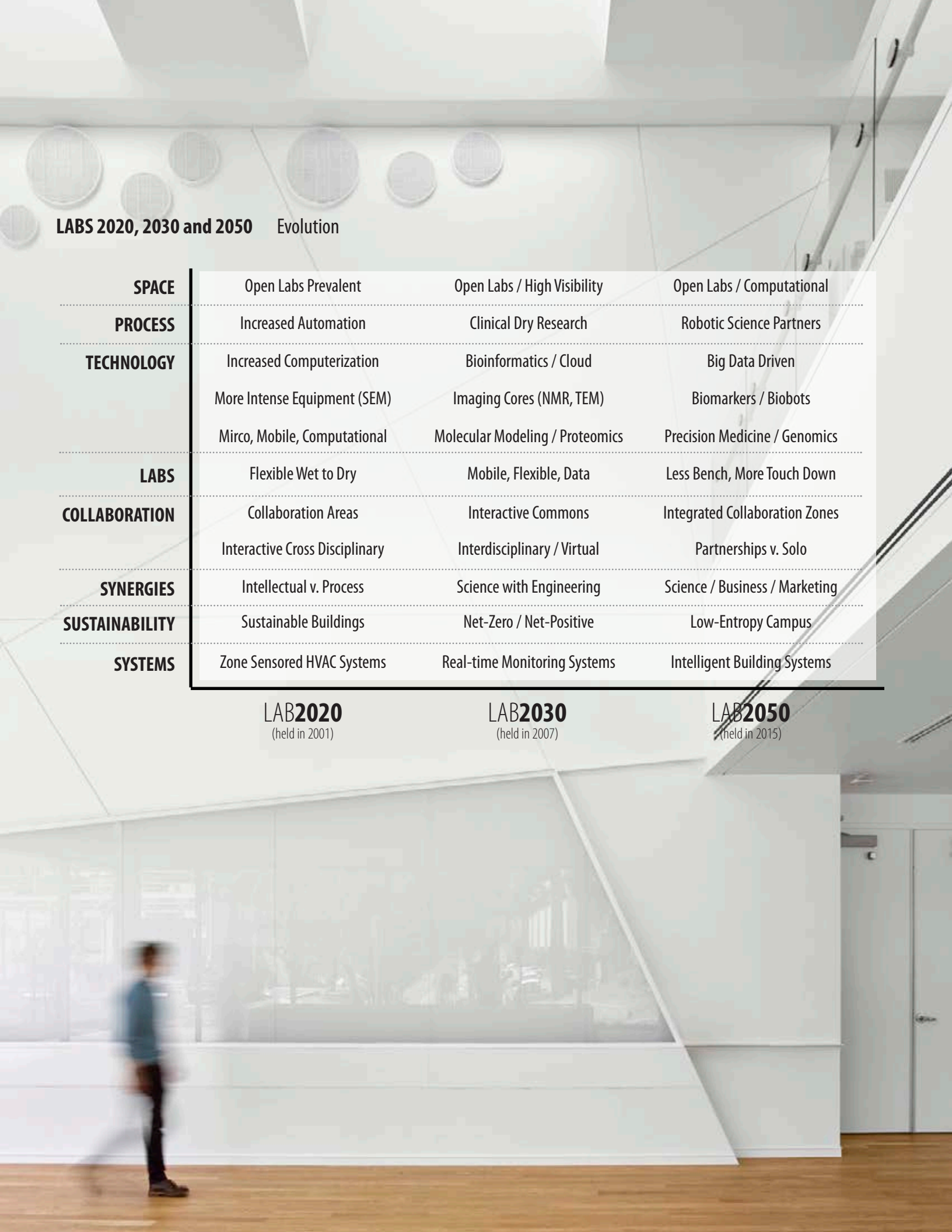

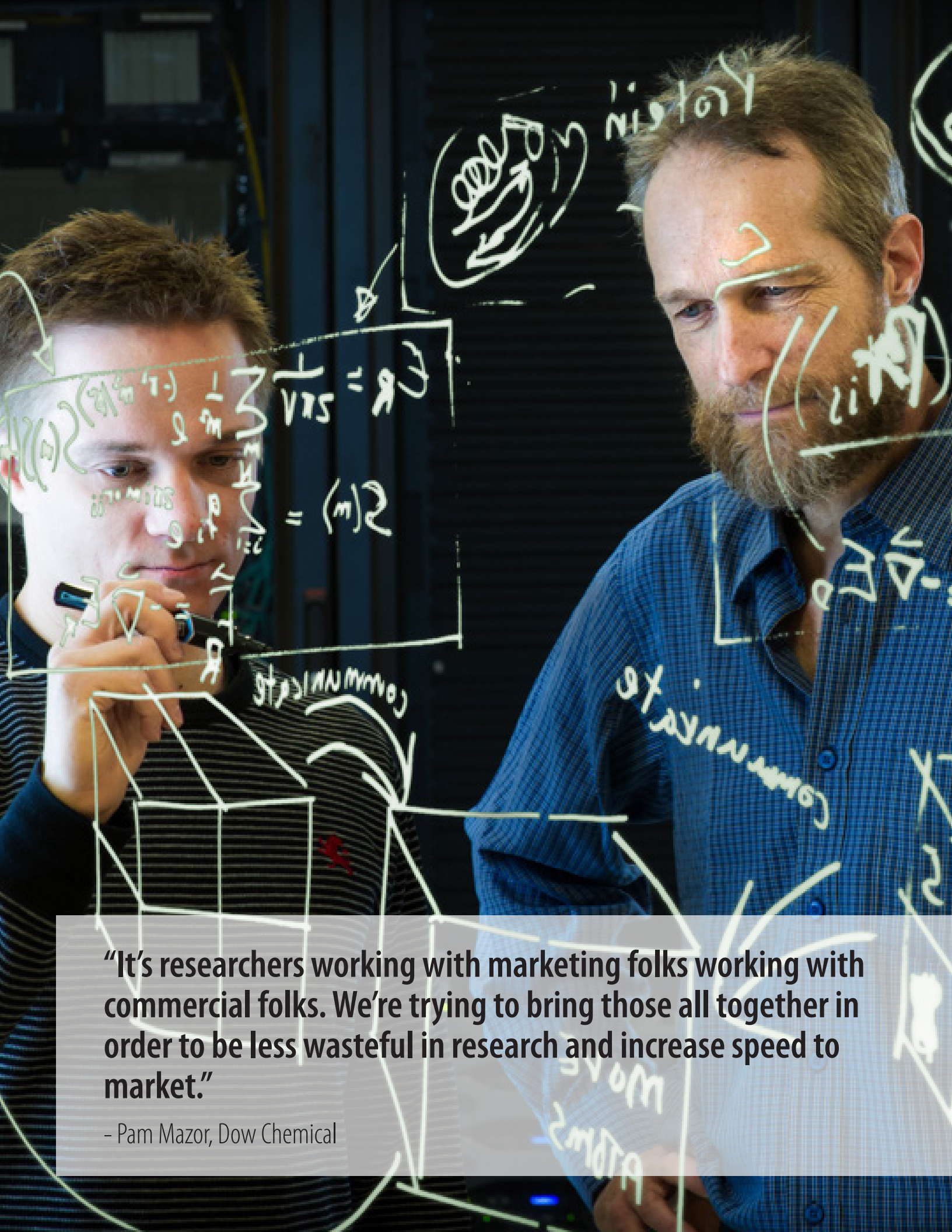

**“It’s researchers working with marketing folks working with commercial folks. We’re trying to bring those all together in order to be less wasteful in research and increase speed to market.”**

- Pam Mazor, Dow Chemical

# LAB2050 | Linkages

As the LAB2050 teams set out on their assigned topics, we quickly realized there would be significant overlap between groups. The below diagram represents the network of relationships between each topic prior to our in depth discussion with our Advisors. Major themes— like big data and virtual environments— became very prominent in the teams’ research.

The next few pages outline each group’s research throughout 2016 and although each took different approaches and perspectives, it is important to note the similarities. With the Advisors on hand in during our face-to-face meeting in Detroit we were able to study and discuss the inter-relationships to better determine key takeaways and how to optimize overlap when it comes to planning and designing the laboratory of the future. Those final findings, which shifted slightly from the below graphic, are outlined at the end of this document under “Key Findings.”

## LAB2050 Overarching Themes and Linkages

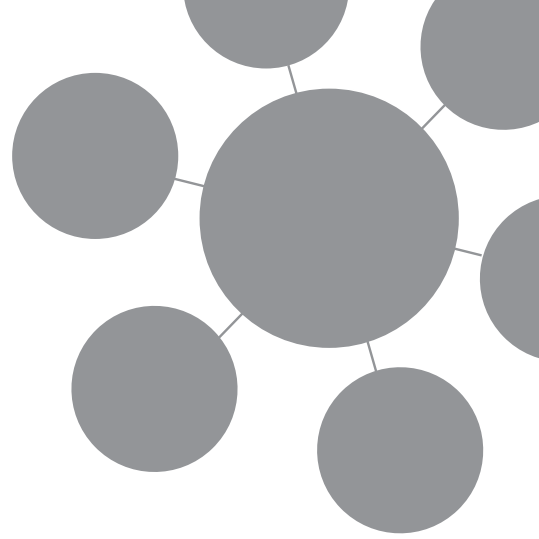
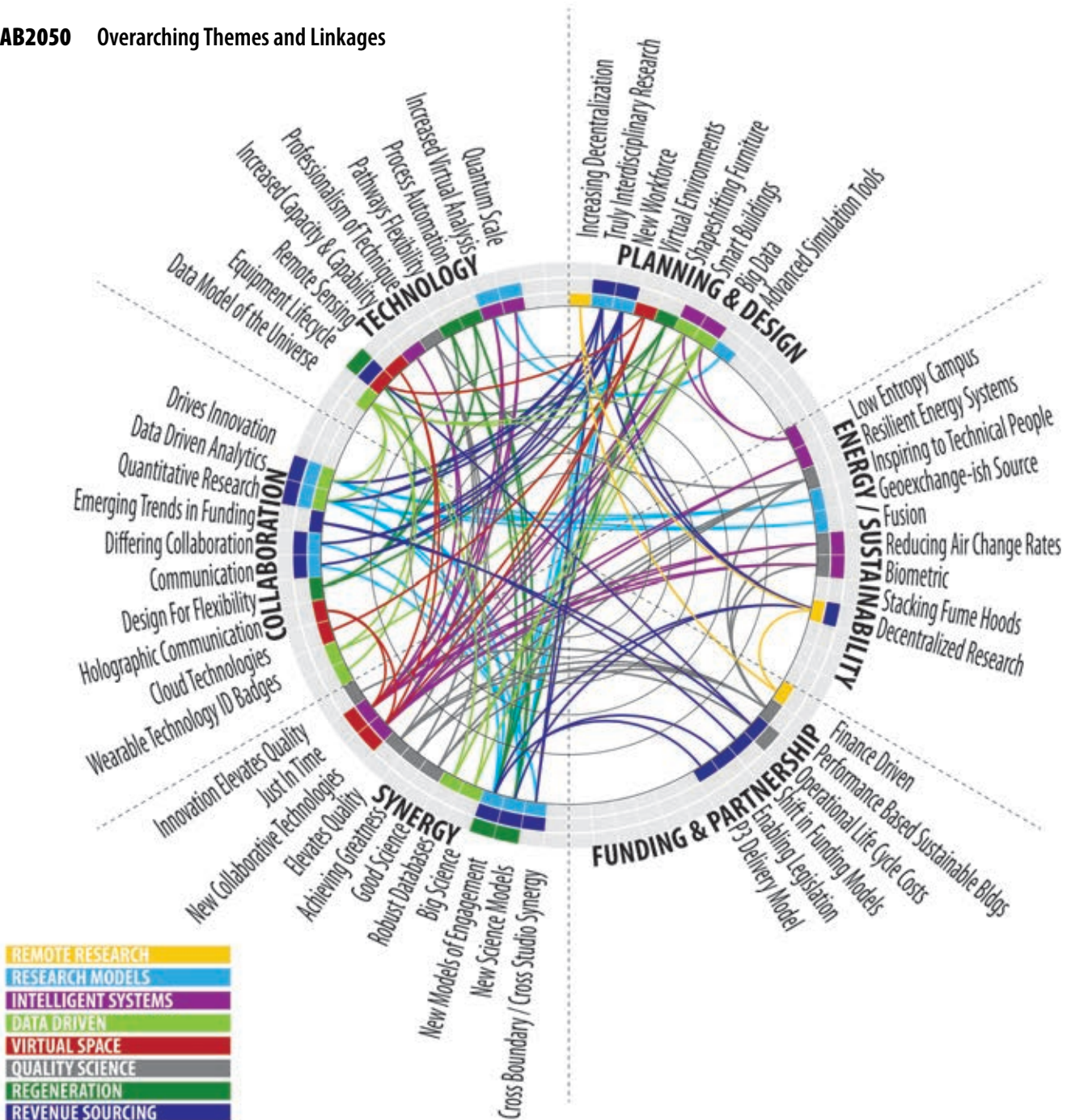



# LAB2050 | Technology

## Hypothesis

**Increased automation** in the research setting will result in decreased space allocation and increased productivity (perhaps measured in terms of throughput—tests per unit time—or revenue generation); using historical data and case studies we'll explore the related concepts of team-size, how much space is enough, and the march of the machines.

## What we discovered

A review of medical imaging technology reveals that analytical and diagnostic equipment has a predictable life cycle with implications for facility design. Case studies show that this equipment generally improves over time, delivering increased capacity and capabilities in a smaller physical footprint and at greater energy efficiency. This occurs in parallel with other advances in technology, as part of an ecosystem of innovation; computerized tomography, for example, would not be possible without advances in hardware and processing speed.

As technology advances, some types of equipment go through a period of rapid obsolescence, becoming almost disposable. Others are optimized as mature technologies that fill a particular niche. X-ray machines, for example, have not been abandoned despite the development of more powerful imaging technologies. As a result, the space impacts of new technologies tend to be cumulative over time. Similarly, while repetitive tasks or those with other fixed parameters can be automated, this does not preclude the need for space that fosters creative interaction among people.

## How this will influence design

Technological innovation is unlikely to result in spatial efficiency. More equipment requires more space and more resources to operate. There is always more stuff. However, potential disruptors to this predictable equipment life-cycle. Those include scale, automation, artificial intelligence, visualization and simulation (see diagram below).

## POTENTIAL DISRUPTORS



### scale

When the research subject is tiny—nanoscale—or vast like the cosmos, the equipment required to investigate those regimes exceeds the scale of most facilities. Like the accelerator at CERN or the Facility for Rare Isotope Beams at Michigan State University.



### automation

Current models of automation result in marginal increases in space efficiency; fully automated labs may result in very dense assemblies of analytical equipment, generating remarkable gains in space and resource efficiency.



### artificial intelligence

Robots as intellectual, creative partners have the potential to redefine research and our conception of the “laboratory”



### visualization

If physical analysis can be done “in the cloud,” equipment space needs may decline.



### simulation

Simulation, particularly of plant and animal models, has the potential to significantly reduce space need.



“Tasks done within fixed parameters will be done in an automated way in the future. I think that in some ways, that's a foregone conclusion, and we're just waiting for the robots to arrive.”

--David Johnson, LAB250 Technology, SmithGroupJJR

### Medical Imaging A Case Study

While advances in imaging technology have resulted in higher resolution and throughput, earlier generation technologies haven't been abandoned. Rather, technologies like X-Ray have been optimized for a range of diagnostic imaging, resulting in cumulative space need over time.

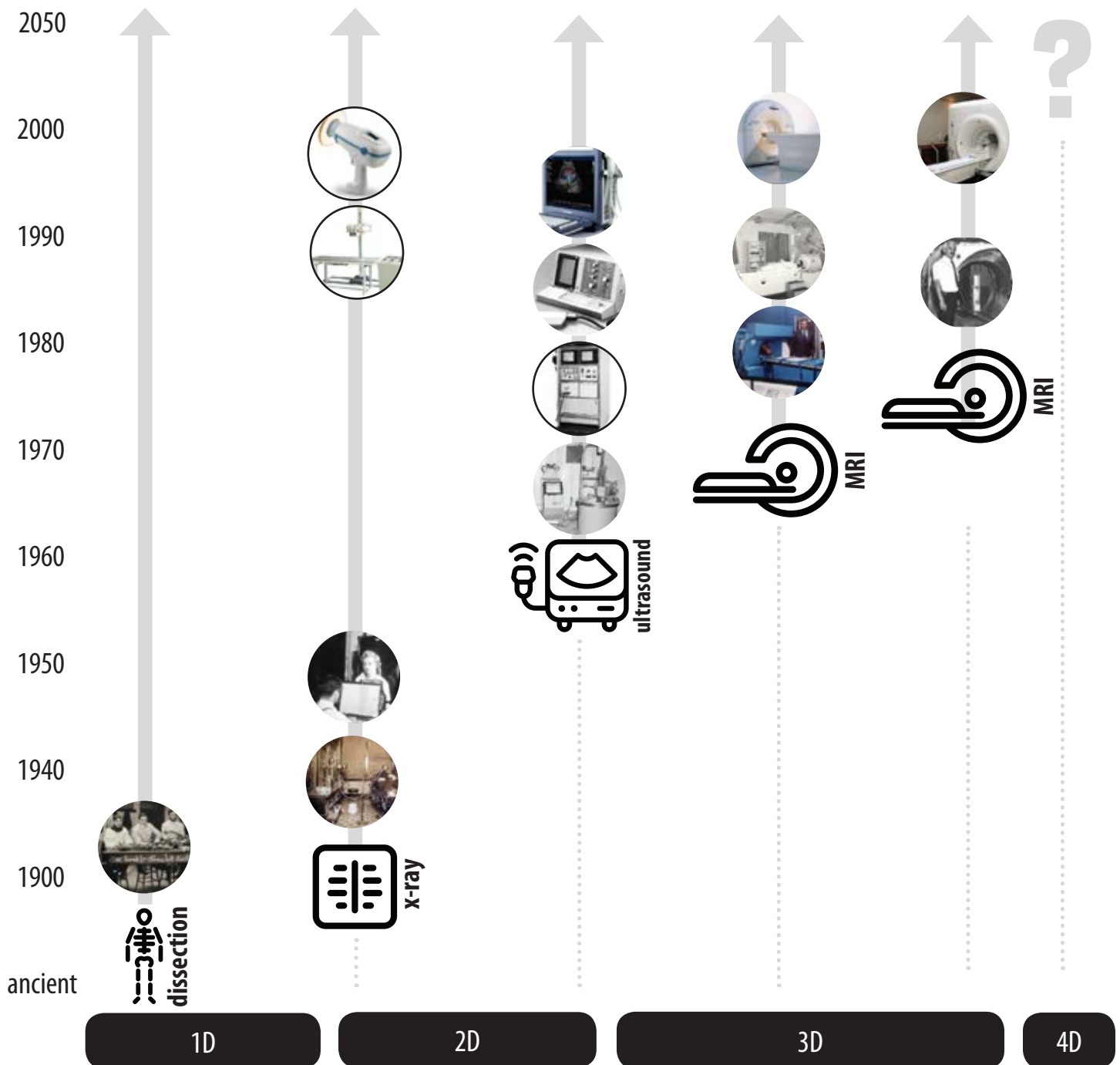

# LAB2050 | Collaboration that Innovates

## Hypothesis

Scientists and research staff will form enhanced collaborations; these collaborative groups will function in innovative ways and with new tools to quicken the pace of research, speed the path to product development, and leverage new technical capabilities.

## What we discovered

Collaboration enables us to move faster. Scientists and research staff are forming **collaborative groups** that function in innovative ways, using new tools to speed the pace of research and clear the path to product development. Proximity encourages collaboration. People generally interact with people within a 50-foot range of their office or work area. Engaging people to cross this barrier leads to stronger, better, faster collaboration. For example, whiteboards installed in elevator lobbies and other gathering spots inspire people to share ideas. Shared equipment, staff and other resources may likewise encourage collaboration, with the added benefit of cost savings. Bringing interaction and support space into the lab environment may increase efficiency. But as in all areas of lab design, safety issues are paramount in considering this type of layout.

Increasingly, we are finding that collaboration must happen across the globe through digital means. While the face-to-face meeting will always be the gold standard for interaction, virtual meetings conducted via phone or videoconferencing, holographic interfaces and similar technology can support collaborative teams, particularly those that are geographically distant. Research teams are able to share data, test results and incoming information, in real time, from anywhere they have access to Internet connected equipment. The team can then react, collaborate and review data quickly, moving the research forward. Connecting management and cultural practices to collaboration is what makes it successful.

## How this will influence design

Bill Nye recently said, “Everyone you will ever meet knows something you don’t.” To that end, facility designers for research environments will continue to strive to draw people together—to encourage the human interaction that is critical for innovation—for decades to come. As technology evolves, physical and virtual spaces

will continue to flex and support different types of collaborative teams. The major difference from today will be where the teams and research are located in the universe.

The lab will always be the crux of research; however, the lab and the benchtop will increasingly become the focus for collaboration. Data will be pulled simultaneously from equipment and researchers in multiple locations; shared across the cloud (or something even more esoteric) and discussed real time over monitors and live walls in the lab. Models will be shared holographically and individuals will walk through and manipulate data that will deliver immediate analytics to the asunder team.

Fact finding, data gathering, analysis and writing have long been thought to be “heads down” inwardly focused work, and while spaces must still be devoted to quiet seeking tasks,

teams will increasingly pursue data analysis and research as a team activity. Agile spaces that can accommodate information sharing between dispersed teams and partnerships will be crucial and far more robust than mere conference calls or email. Spaces will need to accommodate geographically diverse teams sharing detailed and sophisticated data and images, in real time, with a personal, interactive interface.

Individuals entering the workforce from this point forward have never known a time without a rich connection to technical tools and digital communication. This will only continue to escalate over time. This group all those thereafter—who have been using computers since their childhood—live, breathe and interact with technology. Their continued familiarity and ease with technology and information exchange will skyrocket the need and use for collaborative technology to a higher level.

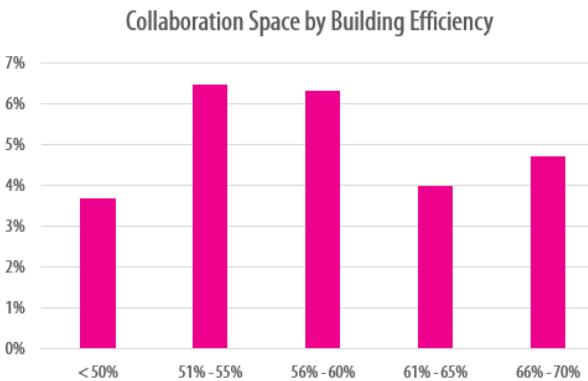
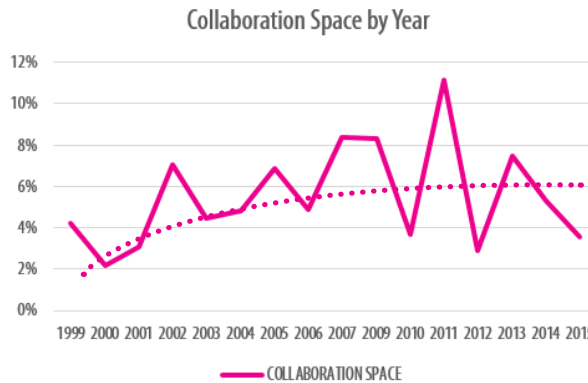

Space Allocation SmithGroupJJR Projects 1999-2015

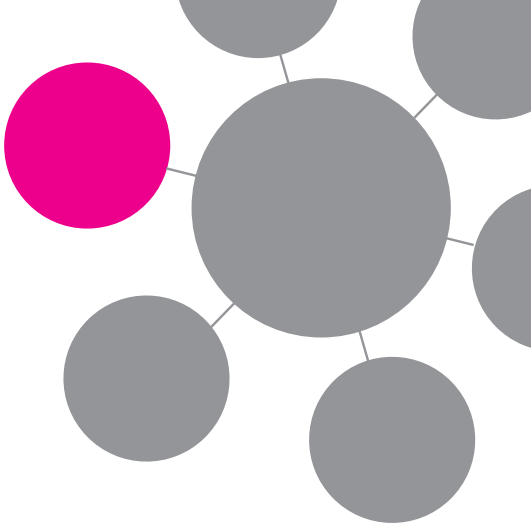

Invention is the result of human friction, of people with different backgrounds and skills and ideas bumping into one another, sparking fresh thoughts and collaborative visions.

—Randy Rieland, "Why Living in a City Makes You More Innovative"

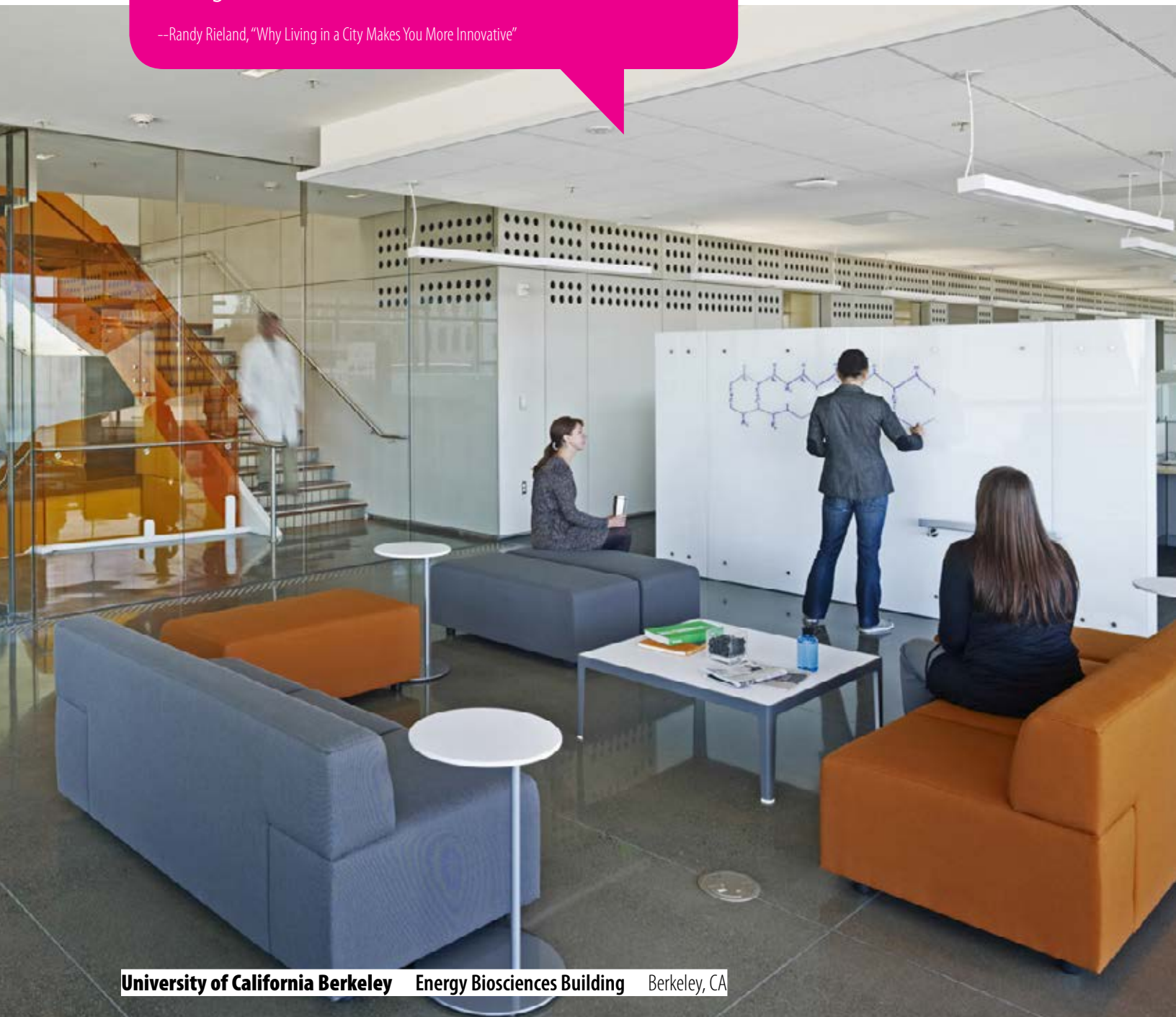



## Hypothesis

Synergistic alliances currently exist independently within the scientific community and within the architecture, engineering and construction (AEC) community. If researchers and AEC professionals develop similar alliances together, the pace of innovation and discovery can accelerate and all stakeholders will experience increased value.

## What we discovered

Synergy is more than partnership, it's the production of something greater than the sum of its constituent parts. The International Space Station is an excellent example of the innovation that can be achieved through synergy between disparate disciplines and groups. Since 2002, more than 90 nations—some past enemies—have used the station to conduct research in biology, physics, astronomy and other areas. The collective investment and collaboration of these groups has accelerated discoveries in robotics, crop development, telemedicine, and water purification, as well as other areas, helping to solve major problems and improve the quality of daily life on our planet. This type of interdisciplinary collaboration and communication leads to smarter decisions faster.

Similar collaborative efforts will lead to new synergies within the AEC community as the line between designers and makers continues to dissolve. Emerging practices like prefabrication, digital fabrication, mass customization, rapid prototyping, and robotized construction are steadily entering the mainstream and will no doubt continually become more prevalent. Significant and even disruptive changes to traditional AEC-O (owner) team structures are anticipated and will prompt shifts in existing contracting and delivery methods, changing how risks and rewards are shared between parties. Similar shifts are already taking place in laboratories, as researchers continue to tear down silos between disciplines to secure limited funding.



**Closed Laboratories at Allied Chemical in 1967**



**Open Laboratories at Michigan State University 2014**



## How this will influence design

To help optimize synergy in laboratories, designers will focus on the creation of open, agile spaces that are highly adaptable to future change. “Just in case” and “just in time” strategies will make way for “in no time” as flexible and reusable assembly techniques emerge alongside robotized construction. Shared, translational and public/private spaces will increase opportunities for different disciplines to interact—formally and informally—and work collaboratively. Facilities will be designed to engage all stakeholders, including the community, in order to maximize interest and spark creative synergies.

**Big data** will also be a major factor as the development of robust product and cost information databases enables the utilization of mass customization processes in design and construction. Design software will interface directly with these databases, with real-time calculation of costs running in the corner of the screen (think “build your own vehicle” offered by automakers). Other strategies using data will be innovated by research/implementation teams towards discovering global solutions for environmental and human health concerns.

Today, one goes online to immediately understand what a car costs, because once options are clicked there is enough information to provide a cost. Could that be done from a construction standpoint where there is a robust enough database, which becomes a real time meter for building design and cost?

—Randall Daniel, LAB250 Synergy, SmithGroupJJR

# LAB2050 | Funding and Partnerships

## Hypothesis

Increasing partnerships to broaden funding sources is increasingly critical for research to stay relevant and to grow.

## What we discovered

Research institutions must partner or perish. Developing **partnerships** to broaden funding sources is increasingly critical for research to stay relevant and grow. Research is the backbone of innovation and a

means by which institutions can engage the community. Government continues to be a major source of funding; private contributions represent an area of growth. Public-private partnerships (also known as PPPs or P3s) use a delivery methodology that is relatively new in the U.S.: private investment in public projects.

P3s cover all aspects of a project, including financing, design, construction, maintenance and operation, with contracts that generally run for decades (often three). The cost of capital can drive the financial success of these arrangements. A developer may choose to sell the operations and maintenance functions to another party during the term of the contract; while the developer would still be responsible for contractually-obligated services, the potential for hand-off is a concern. Research and academic institutions should also consider what might happen if their own vision or needs change midway through the contract.

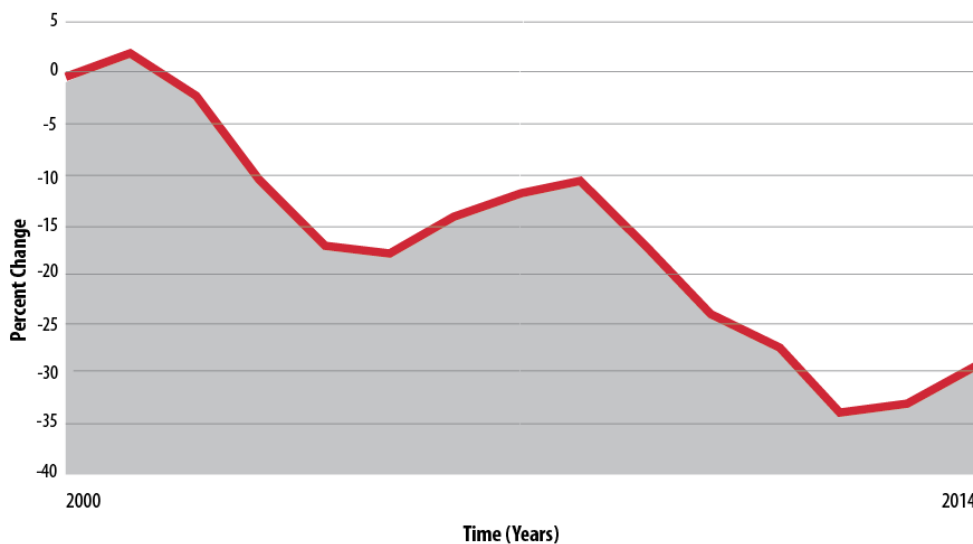

### Percent Change in State Support for Higher Education (All Colleges and Universities) per Full-Time Equivalent Student

(Source: Public Research Universities Recommitting to Lincoln's Vision: An Educational Compact for the 21st Century)

Grants and research partnerships are also essential avenues of support. Research organizations should contemplate if or how donor backing influences what is built or studied. Colleges and universities are experimenting with several means of fostering partnerships to fund research facilities, including P3s, government support, public and private grants and arrangements with corporate partners. There is an apparent trend in higher education towards hiring developers to manage campus facilities. This trend is also affecting large scale private sector research companies and their

associated facilities. These companies are outsourcing building design, operations and maintenance to save on the bottom line and enhance focus on the organizations' research goals.

## How this will influence design

Contracts that include responsibility for long-term building operations and maintenance favor high-quality construction and the

implementation of safer, more sustainable designs. Energy-efficient infrastructure is less likely to be value engineered out of a project when the parties bearing the upfront costs are also realizing the savings provided by sustainable designs and equipment over 30 years or so of a facility's life.

As research organizations make more of an effort to connect with potential partners, areas for industry outreach may become a more important aspect of lab facility design. The need for long term flexibility is becoming even more critical in the design of today's research facilities as the funding models change and shift.



“About two-thirds of our open faculty positions are fully funded by partner monies in one way or another, having no state or university money in them.”

--Jeffrey Dwyer, PhD, Michigan State University College of Human Medicine

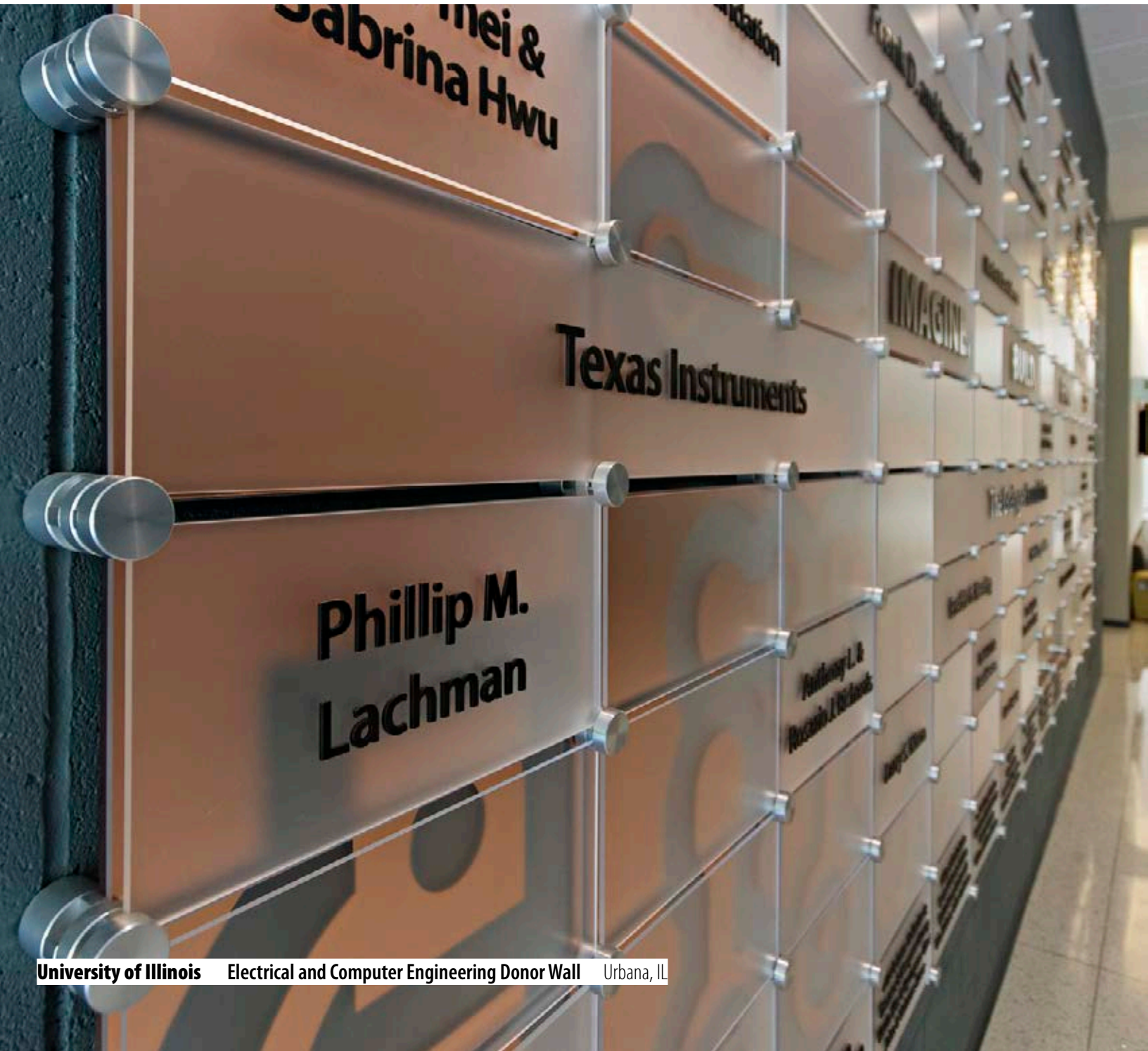
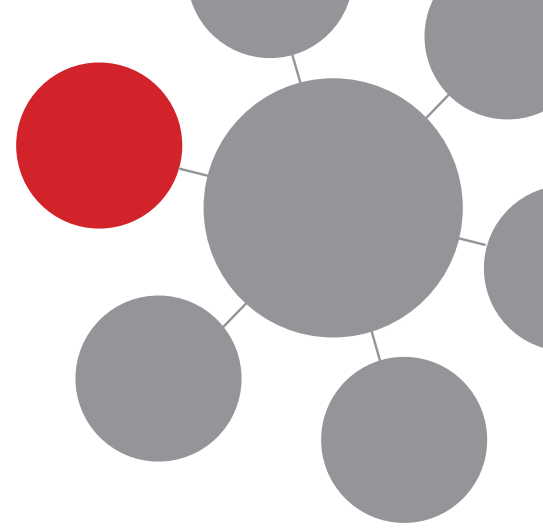

**University of Illinois** Electrical and Computer Engineering Donor Wall Urbana, IL

# LAB2050 | Energy and Sustainability

## Hypothesis

In 2050, science and technology will thrive on low-entropy/low-water campuses comprised of buildings with site-specific biomimetic skins, containing delightful laboratory spaces that host and promote diverse and resilient communities of scientists, virtual artificial assistants and low-power research equipment.

## What we discovered

Too often, research sites are dotted with energy silos and conventional HVAC systems transferring heat over large temperatures. These are by nature high in entropy—energy not useful for work. A transition has begun toward Low-Entropy Campuses that frugally reuse high- and low-grade waste heat, minimize temperature approaches, and improve indoor environmental comfort, offering gains not only in energy but human and organizational effectiveness. The best source of thermal energy is often already on site; a data center, for example, may produce enough BTUs to heat a campus. Future energy systems will focus on reuse, storage, and renewable energy sources like photovoltaic and wind power, with a long-term hope for practical fusion.

Water and energy are related at many fronts, one being that less heat rejection means less cooling tower evaporation. Lab plumbing designs should consider water as multiple-stream systems, as with energy, to be reused as many ways as possible: rainwater and cooling coil condensate as tower makeup, for example. Careful site selection, resilient design, daylighting and biomimetic designs and materials (imitating properties of plants, animals or ecosystems) can also improve a lab's sustainability.

Labs are now designed primarily for human use, but the needs for space, equipment, energy and water may change as artificial assistants perform more work.

## How this will influence design

Building sites may be selected based on sustainability criteria like the ease of heating and cooling at a specific location. Research buildings and campus infrastructure will utilize efficient energy and water systems that recapture and reuse as much of these resources as possible. Efficient power and water use will help make labs more **resilient** to catastrophes like major storms. There will be renewed interest in installing cisterns for water conservation. As robots assume more lab work, the space and energy needed for equipment like ventilation hoods is likely to be reduced. Decentralized and computerized lab work may also result in a reallocation of or reduction in lab space, and the associated use of resources.

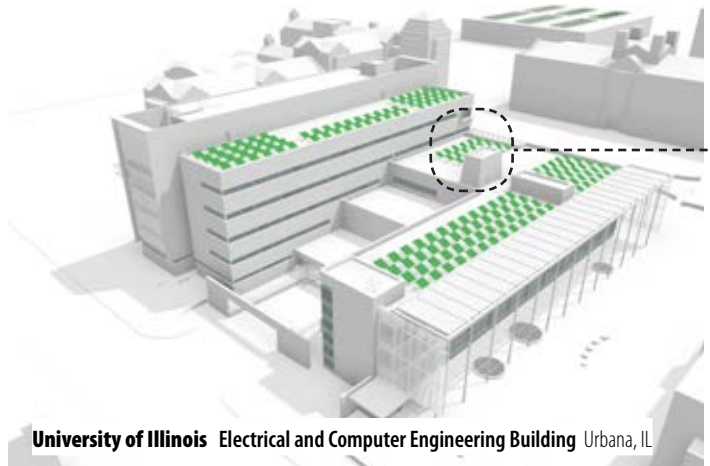

## living laboratory

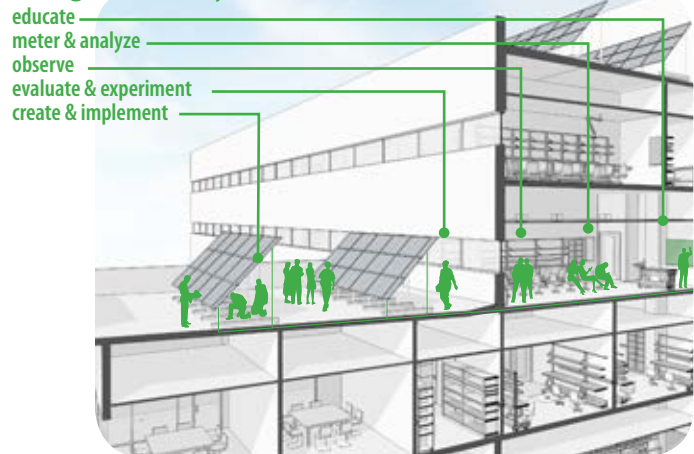



“So what's better? Ten megawatts just dissipated to the Arctic Circle, where the ice sheets are melting, or somewhere you can use it? So you have to look at the whole campus. What's in your campus? The best BTU is probably one that's already there.”

--George Karidis, Energy and Sustainability, SmithGroupJJR

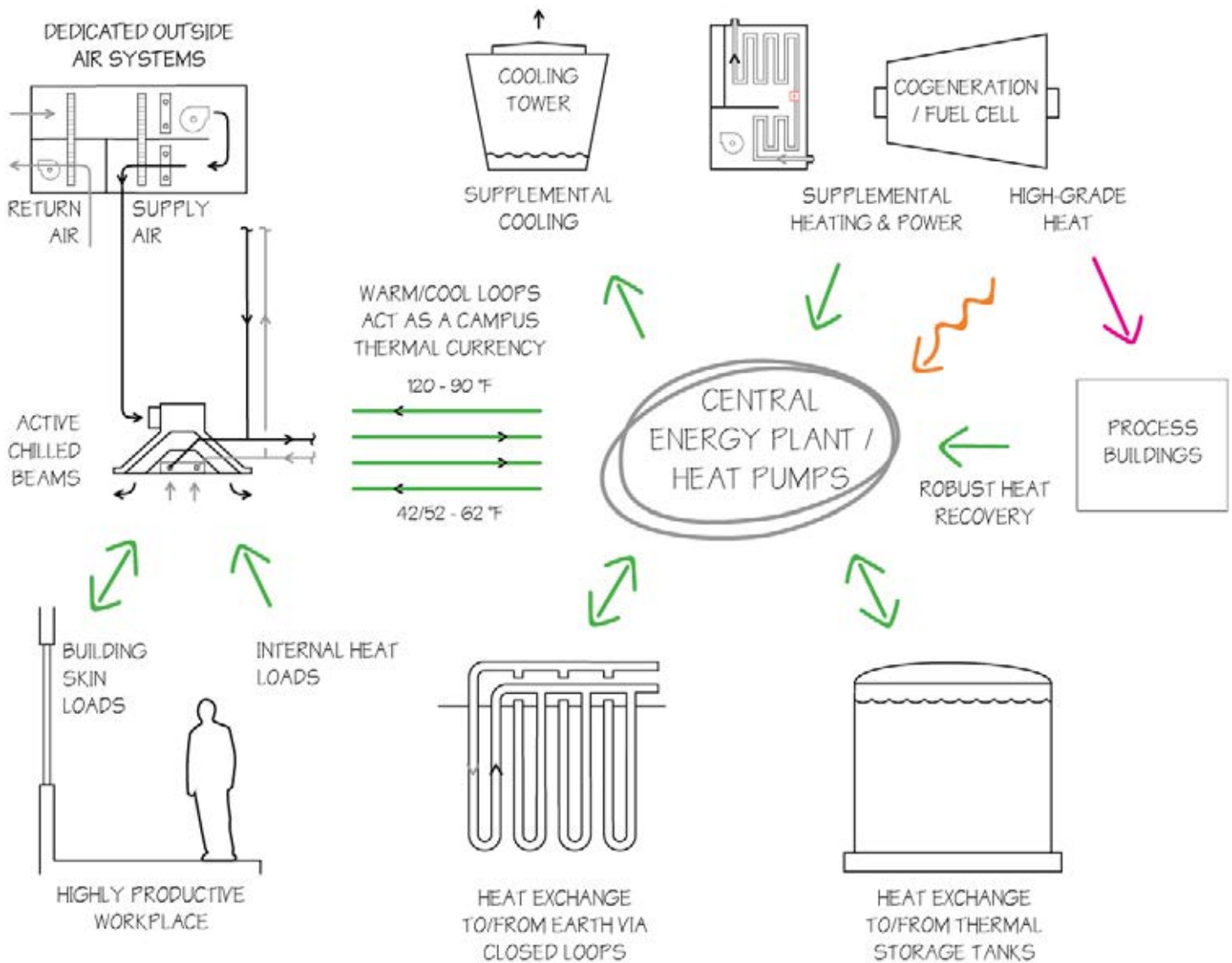
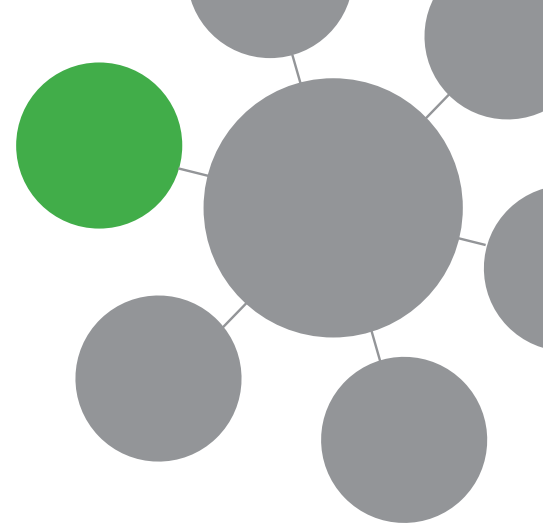

Chilled Beams + Hybrid Geothermal plants provide a low-entropy “thermal currency” of cool and warm water to synergistically link a campus, earth, and waste/renewable energy streams—with less carbon, less water, and less cost. The best BTU is often one already on the campus.

# LAB2050 | Planning and Design

## Hypothesis

With new breakthroughs in robotics, visualization, and virtual environments, the scientific community of the future will no longer be centralized and self-contained, but will be de-centralized, global, and virtual. Through artificial intelligence, nanotechnology and smart equipment, the way we design future scientific communities and the research environment will also transform, enabling the creation of ‘Living Labs’ that can monitor and adjust environmental conditions, energy use, light, and materials in response to robotic and human occupants.

## What we discovered

Technology is enabling people to conduct research in an increasingly collaborative, **global** fashion. As campuses become more decentralized, the longevity of a particular place, like a research park, can be secondary to securing the future of an institution or study. But planners and designers can't simply state that place doesn't matter. Top researchers want to work side-by-side with other top researchers, since innovations tend to occur at the intersections where people gather. Physical space can be augmented by virtual environments like the online world Second Life, holograms or wearable technology.

As the field of robotics advances, planners and designers need to consider how robot “coworkers” fit into the laboratory and campus environment. Other technical innovations, like smart buildings, flexible furnishings and new data-gathering and design tools, will also impact lab designs. Looking farther ahead, the potential effects of climate change should be considered, as well as the challenges of designing for extraterrestrial environments, such as a low-gravity moon-based lab.

## How this will influence design

Designs will encompass the physical and virtual world. Increased use of robotics may expand the usable area of the lab vertically, to include multiple levels of work space. In addition, pathways for robotic traffic within and between buildings may need to be developed (perhaps separate from circulation routes designed for people). Different safety and accessibility requirements will apply to robots, especially in relation to tasks that are hazardous for people to perform. The needs of a new workforce—with, for example, humans working 9:00–5:00 and robots working 24/7, or humans concentrating on creative work while robots conduct repetitive tasks—will need to be considered.

Innovation happens at the intersections of disciplines, groups, populations. This map represents the innovation ecosystem of Barcelona, which includes startups (magenta), research centers (blue), leading companies (yellow). This system is based on a diverse and compact urban fabric that enables a positive transference of innovation and knowledge to different parts of the city.<sup>1</sup> In the future, **place will matter as knowledge hubs need social density.**

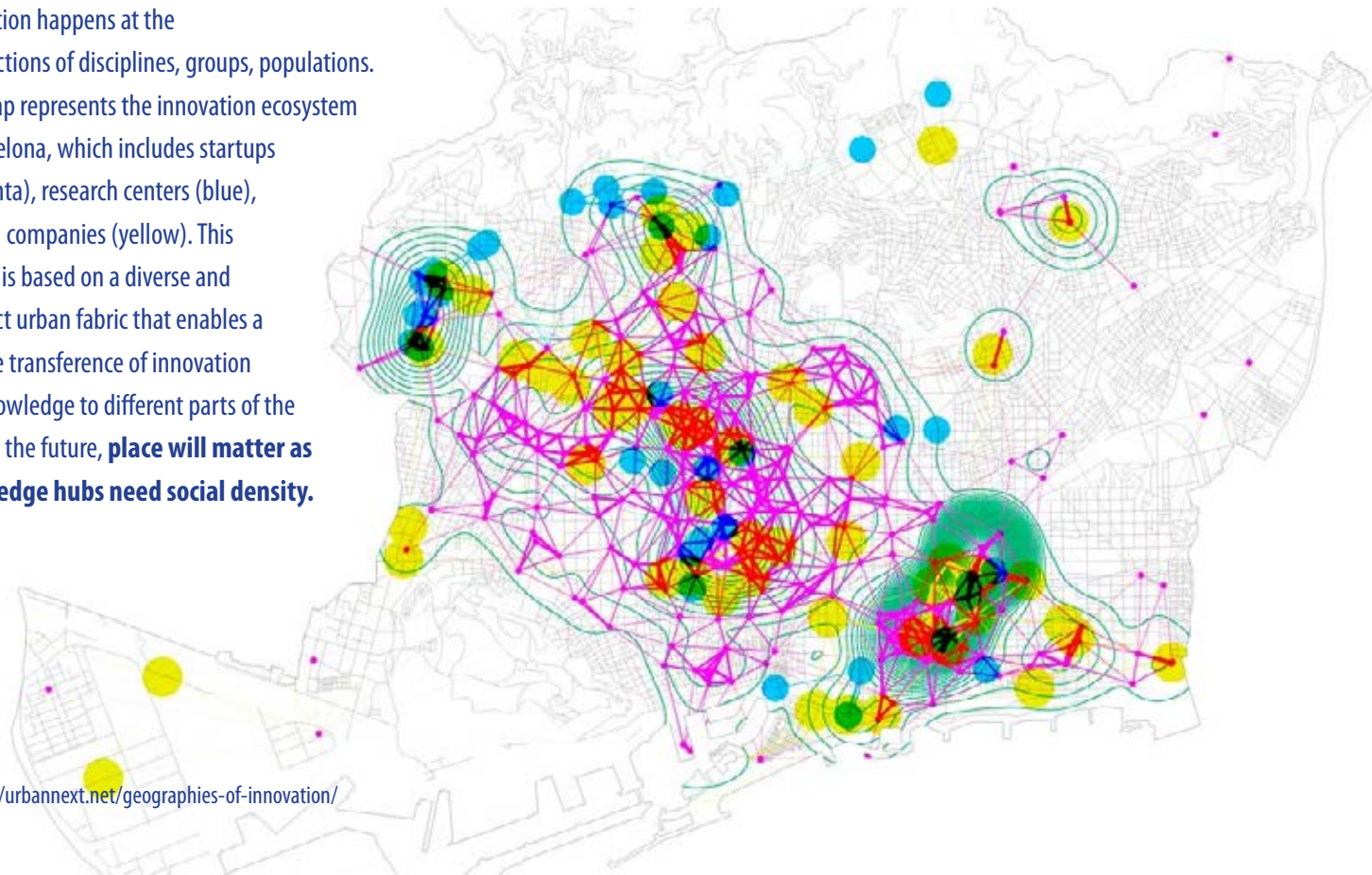

<sup>1</sup> <https://urbannext.net/geographies-of-innovation/>

Technical advances like smart buildings that automatically adjust lighting controls and ventilation, or shape-shifting furniture that can easily adapt to different situations, will enhance building usability and **agility**. The proliferation of digital displays will cause designers and planners to rethink wall space as an opportunity for researchers to review or share data.

As data collection capabilities increase, evidence-based design will have a wealth of information to draw upon. Sophisticated computerized simulation and visualization tools will enable people to engage fully with designs as they are developed. Designs will also be prepared to handle new environmental conditions.

“By 2050 we may have to start thinking of a laboratory of the future for – maybe for the moon, if not Mars.”

--Roop Mahajan, PhD, ICTAS Director and Lewis A. Hester Chair in Engineering, Virginia Tech

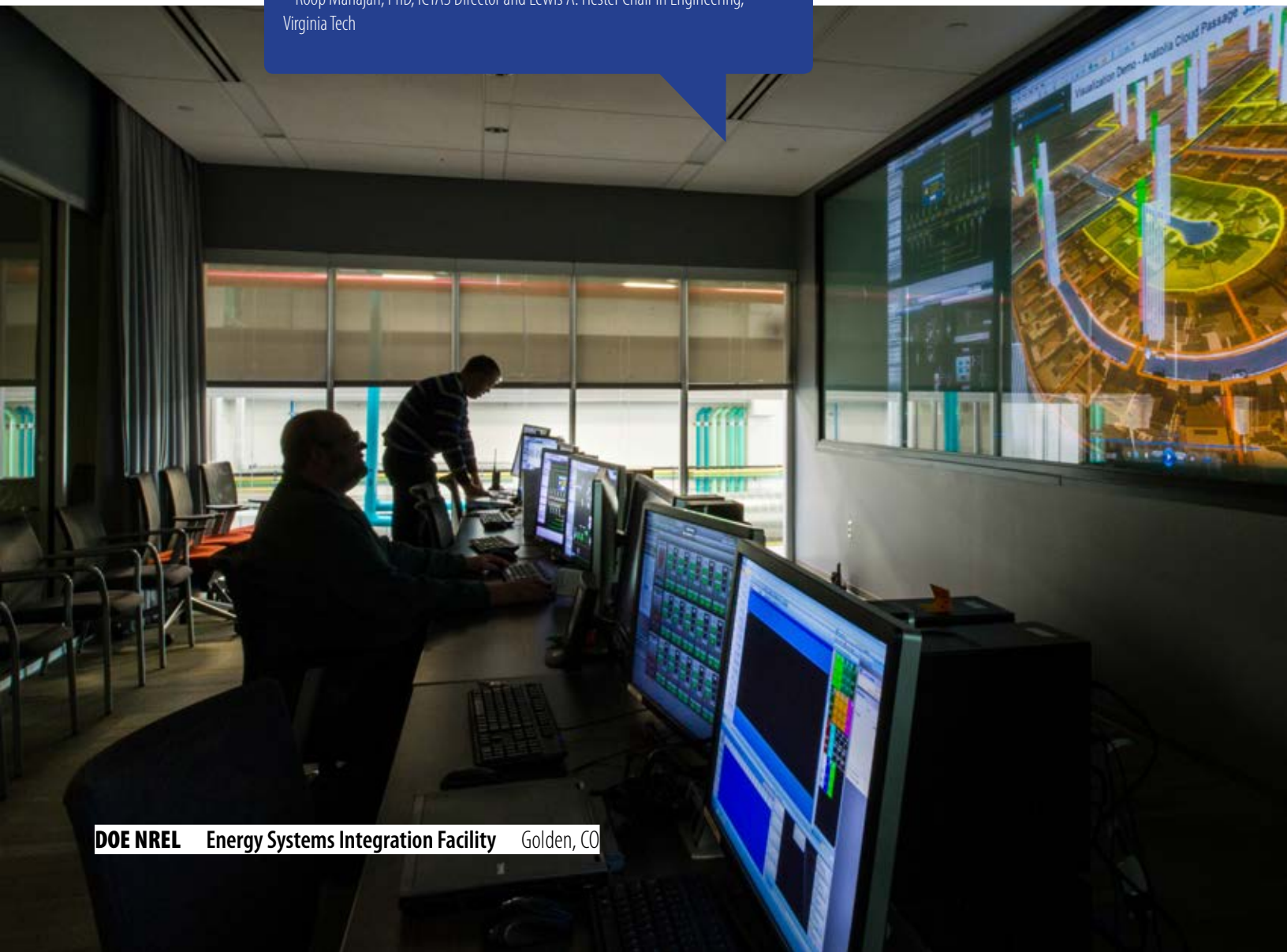



# LAB2050 | Key Takeaways

The following top ten points consolidate the findings of the LAB2050 initiative. SmithGroupJJR and our Advisors advocate these foci for the near and long-term future. Although the team anticipates these will change and flux over time, as we continue to plan and design 40 to 60 year buildings daily, it is important to think about how advanced facility design will respond to the technological and user needs in the future.

## Design for Agility

As technology evolves, physical spaces will need to remain flexible, nimble and agile to accommodate new requirements.

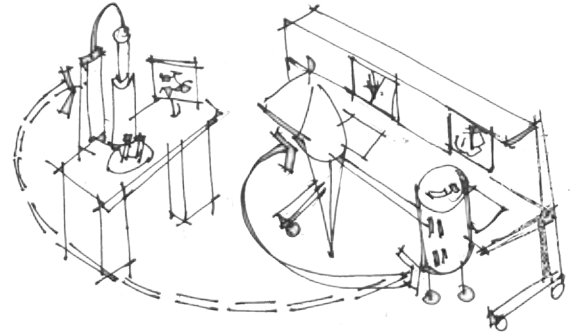

## Automated and Decentralized Experiments

Technology and robots will allow for remote manipulation of experiments, which will affect sizing, space, location and safety protocols, and will ultimately protect science from occupants and vice versa.

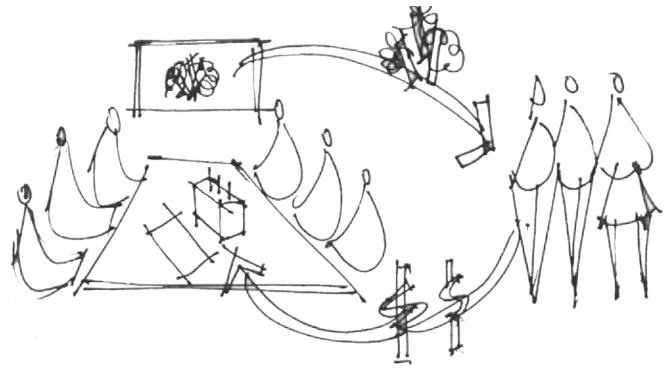

## Partnerships

As government money continues to shift and decline, unique partnerships between universities, corporations and developers will continue to trend upwards. It will have a profound impact on research, pedagogy, funding, design and project delivery.

## Centers for Collaboration

Adaptable space is required as the line between physical and digital continues to blur. Spaces will continue to support teams but must develop enough to accommodate a group sitting next to one another just as successfully as one that spans several time zones.

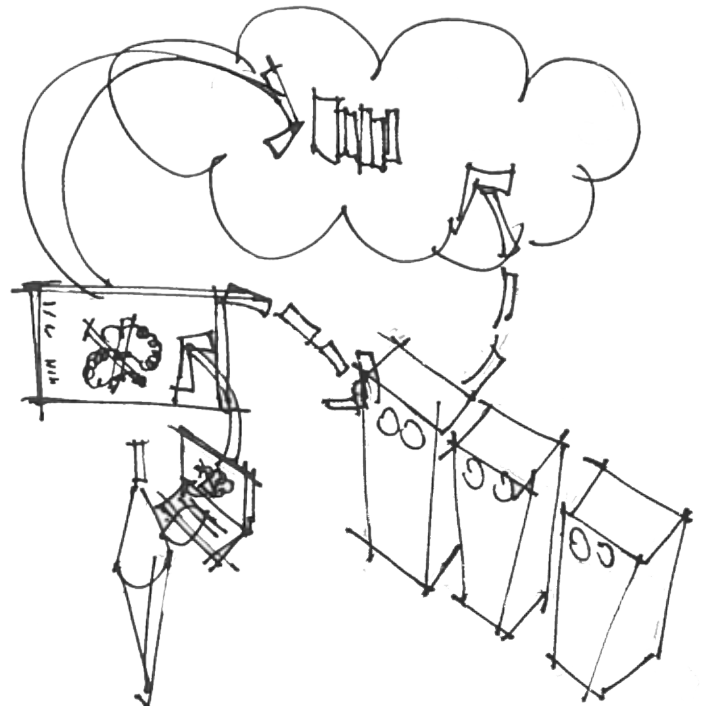

## Finance Driven

Multiple sources of money will become the only way for institutions to successfully grow, operate and innovate. Science endeavors will have to shift focus beyond research to include financial feasibility.

## Big Data

Data will continue to be collected at astronomical rates. Storage will be essential and will become a key component in the efficiency of places through energy reuse from servers and data centers. Designers will use collected data to create intelligent buildings that are not just the vehicle for research, but part of the research.





Click the icon to watch a video from SmithGroupJJR's annual Science & Technology Advisory Board meeting where we reported the LAB2050 findings and dug deep into the research environment of the future.

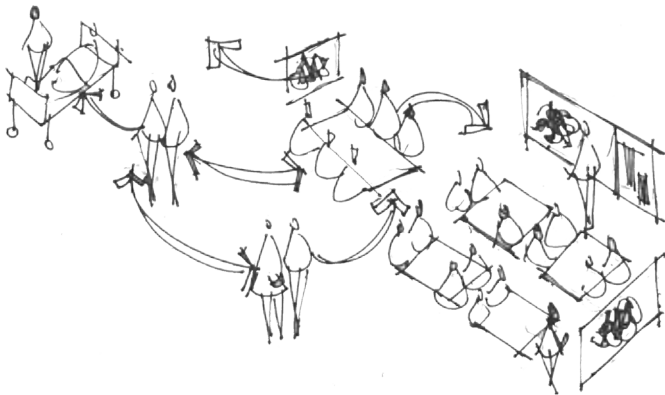
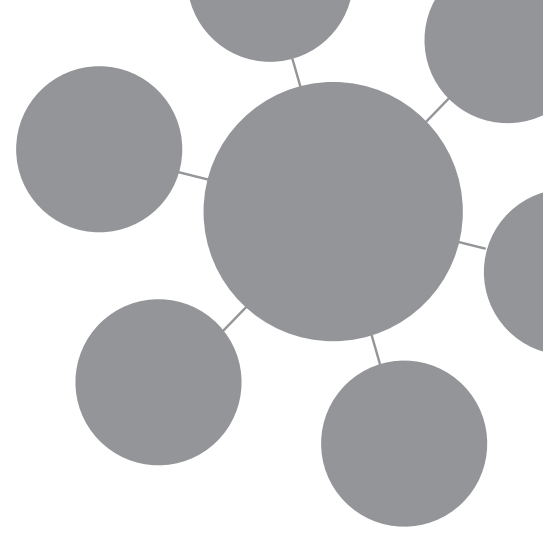

### Place Will Matter

People will continue to make preference-based choices about where they live and what they do. The desire to live in a particular place drives our quality of life. Some places will be more competitive or more attractive than others, independent of how many virtual environments and scientists and breakthrough discoveries are occurring there.

### Global Access to Information

As public research and data continue to grow, global access will become the norm. Networks, from around the world, will be accessed by informatics experts to study, analyze and draw conclusions. This could have a profound impact on the more less known global issues and diseases with efficient and inexpensive ways to research and solve pressing concerns.

### Intelligent Space

Designers will have more data to push evidence-based design and create buildings and spaces that respond to users and need. This will include automatic changes in ventilation, lighting, room colors and technology needs just based on the people (or robots) entering the room.

### Efficiency and Resiliency

Cost and climate change will require reliable energy sources for buildings. This will include, but is not limited to, hybrid geothermal and heat-reuse strategies that provide low-entropy systems to buildings, campuses and beyond. Structures will withstand and thrive during disasters.

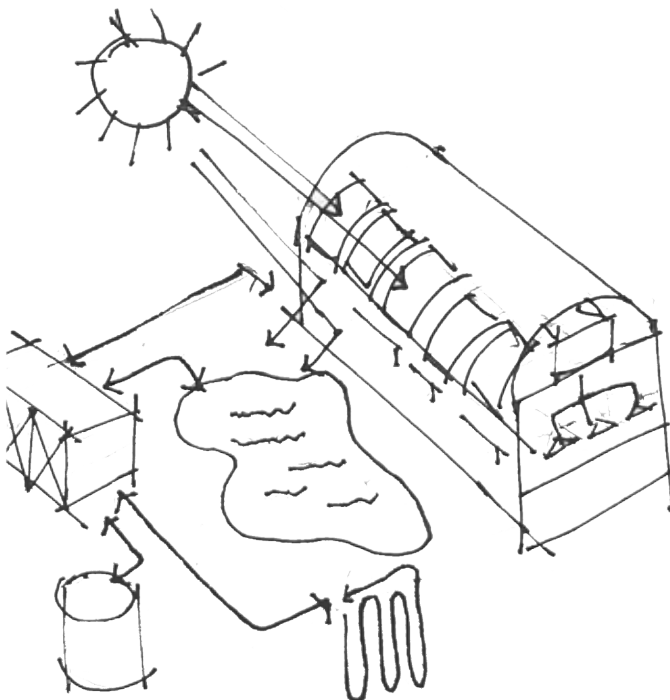



## LAB2050 | Acknowledgments

On behalf of SmithGroupJJR's Science & Technology Practice, we would like to thank our dedicated Advisors who participated with our LAB2050 teams and those who provided invaluable feedback during our meeting in Michigan. We'd like to also acknowledge our

internal teams who completed a tremendous amount of research and analysis to make this project a success. Together, with our Advisors, they worked to envision the characteristics of tomorrow's ideal lab, giving us the knowledge and tools to meet that future.

Patty Boyle (SmithGroupJJR) • Jamison Caldwell (SmithGroupJJR) • Vanessa Cornell (SmithGroupJJR) • **Myron Campbell, PhD (University of Michigan)** • Victor Cardona (SmithGroupJJR) • Mark Cone (SmithGroupJJR) • **Stephen Cotton (University of Louisville)** • **Niraj Dangoria (Stanford University School of Medicine)** • Randall Daniel (SmithGroupJJR) • Adam Denmark (SmithGroupJJR) • **Michael Diamond, MD (Georgia Regents University)** • **Jeffrey Dywer, PhD (Michigan State University)** • Brad Gildea (SmithGroupJJR) • **Jeff Goldberg, PhD (University of Arizona)** • Steve Hackman (SmithGroupJJR) • Chris Heine (SmithGroupJJR) • David Johnson (SmithGroupJJR) • Mary Jukuri (SmithGroupJJR) • George Karidis (SmithGroupJJR) • **Richard Kennedy, PhD (Oakland University William Beaumont School of Medicine)** • Jeff Kocinski (SmithGroupJJR) • Michael Krager (SmithGroupJJR) • Scott Kreitlein (SmithGroupJJR) • **Elizabeth Lawrence, MHA (Michigan State University)** • Seul Lee (SmithGroupJJR) • Michael Paul Krug (SmithGroupJJR) • Marilee Lloyd (SmithGroupJJR) • **Roop Mahajan, PhD (Virginia Tech)** • Roxanne Malek (SmithGroupJJR) • **Pam Mazor (The Dow Chemical Company)** • Reuben McCrory (SmithGroupJJR) • Ben McRae (SmithGroupJJR) • Irene Monis (SmithGroupJJR) • **Inga Musselman, PhD (The University of Texas at Dallas)** • Suzanne Napier (SmithGroupJJR) • Julia Phillips (SmithGroupJJR) • Don Posson (SmithGroupJJR) • Jason Smith (SmithGroupJJR) • **Mark Spong, PhD (The University of Texas at Dallas)** • Kim Swanson (SmithGroupJJR) • Nikki Taylor (SmithGroupJJR) • Rob Thompson (SmithGroupJJR) • **Otto Van Geet (National Renewable Energy Laboratory)** • Chris Vanneste (SmithGroupJJR) • Andy Vazzano (SmithGroupJJR) • Johnny Wong (SmithGroupJJR)

 TECHNOLOGY

 COLLABORATION

 SYNERGY

 ENERGY & SUSTAINABILITY

 PARTNERSHIPS & FUNDING

 PLANNING & DESIGN

 MEETING PARTICIPANTS

 INITIATIVE MANAGERS

**“In order to really solve tomorrow’s problems...we need to understand where science is going and how do we best design facilities of the future to meet those demands.”**

- Andy Vazzano, Science & Technology Strategic Planner, SmithGroupJJR



In memory of Stephen Cotton (1952-2016), a long-time client, advisor and friend to SmithGroupJJR.

**SMITHGROUP JJR**

© 2016